

piu 

Alp Nuhođlu



Sofa



Designer: Alp Nuhuđlu Category: Sofa  
Environment: Indoor Country of Production: Turkey

## Product Details

Beech hardwood frame structure is supported by plywood and MDF panels. The elastic column is used for the seat. Seat and back foam is HR foam and backrest cushions are filled with polyester fiber balls. Either the seat cushions or the backrest cushions can be taken out. Silicon fiber sheet is used before upholstery to give more comfort.

### Leg

Ø22mm tubular metal profile with plastic glides.

## Materials

### Upholstery

Fabric, Leather, Artificial Leather. COM and COL options are also available.

	95cm	180 cm	220 cm	250 cm
textile fabric yardage (mt)	7	9	12	14
real leather square meter(m <sup>2</sup> )	x	x	x	21

### Leg Materials

**Metal Leg Finishes:** Chrome, Electrostatic Powder Coating Colors

Click to view the fabric and material catalogues via bt.design:

[B&T Fabric Catalogues](#)

[B&T Material Catalogues](#)



# Dimensions (cm)

## PIU MODULES

**TRIPLE 250**

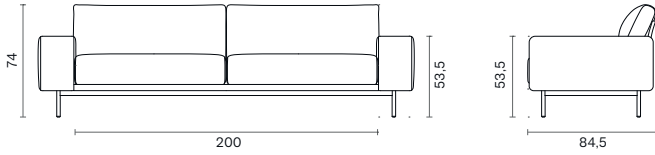

**TRIPLE 220**

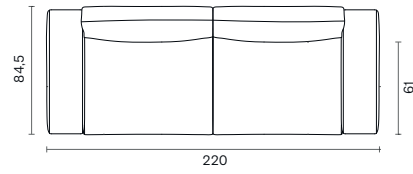
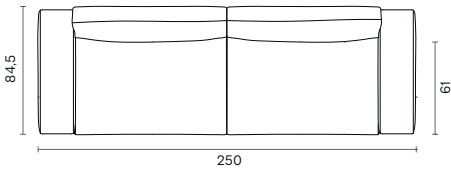
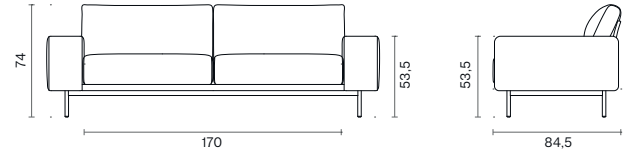

**DOUBLE 180**

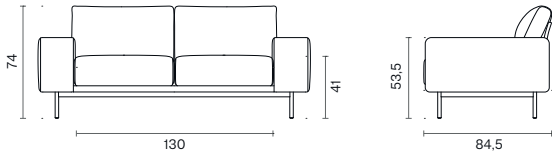

**SINGLE**

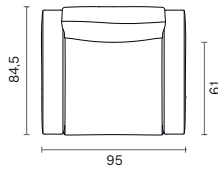
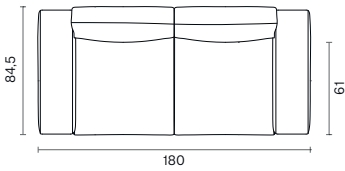
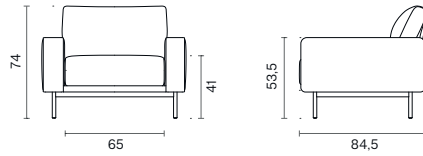

**225 RIGHT - 225R**

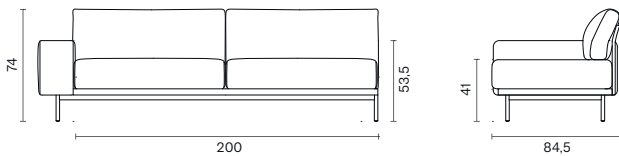

**225 LEFT - 225L**

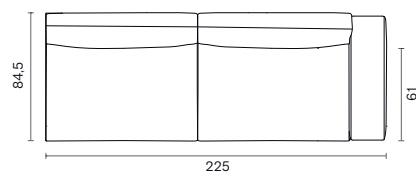
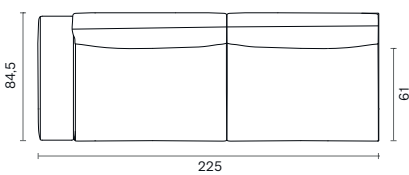
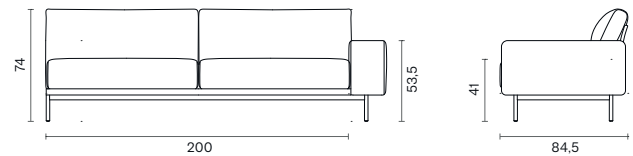

**195 RIGHT - 195R**

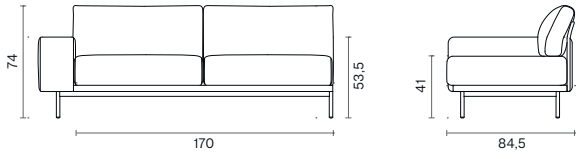

**195 LEFT - 195L**

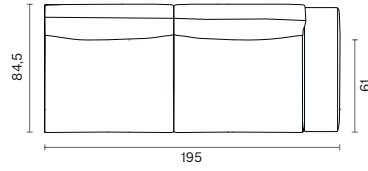
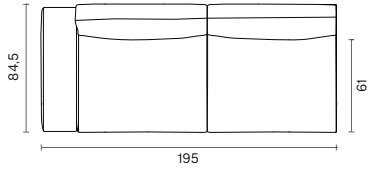
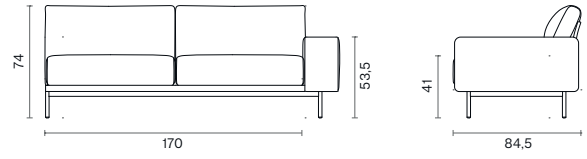

**155 RIGHT - 155R**

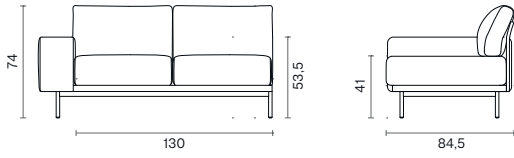

**155 LEFT - 155L**

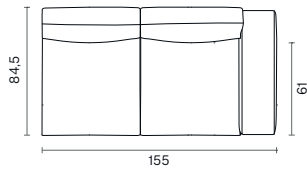
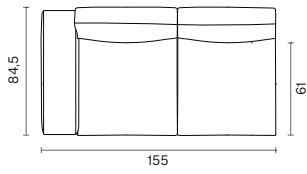
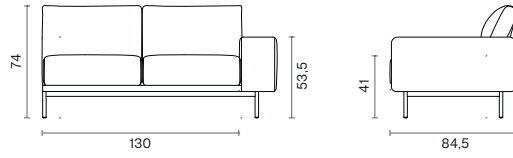

**125 RIGHT - 125R**

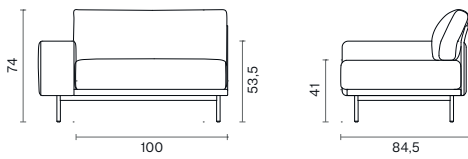

**125 LEFT - 125L**

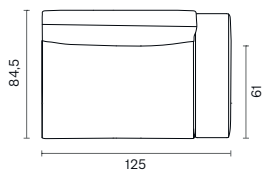
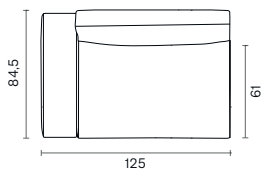
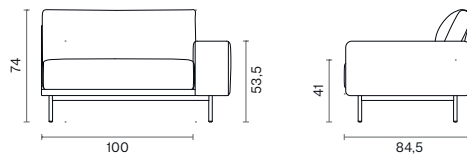

**125 LOUNGE RIGHT - 125LR**

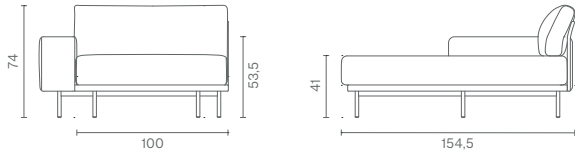

**125 LOUNGE LEFT - 125LL**

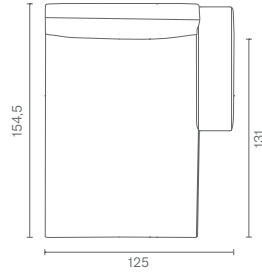
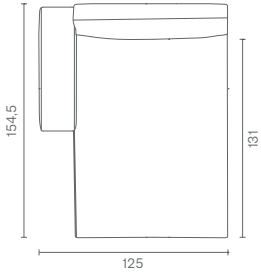
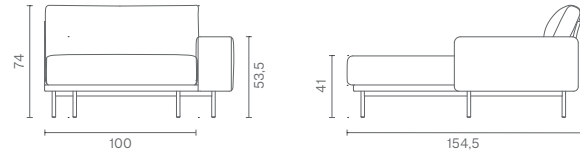

**84,5 CORNER - 84,5C**

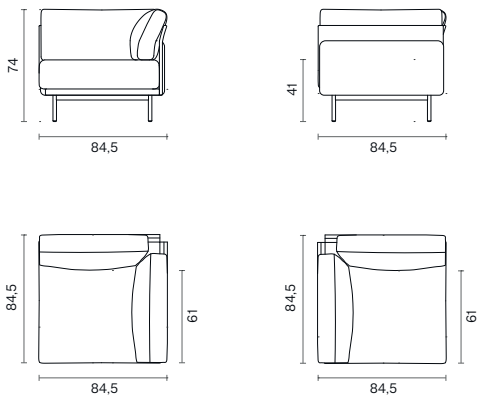

**POUF 41H - P100X100**

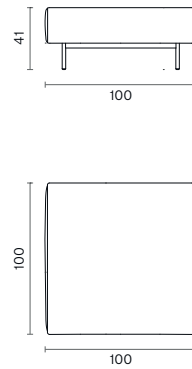

**POUF 41H - P82X82**

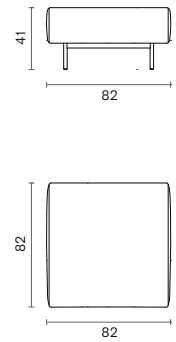

**POUF 41H - P170X50**

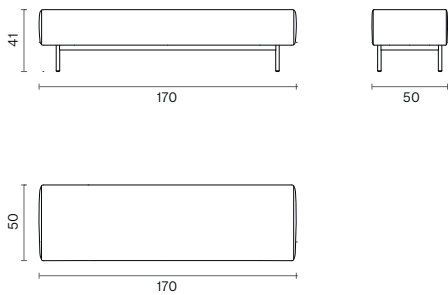

**POUF 41H - P130X50**

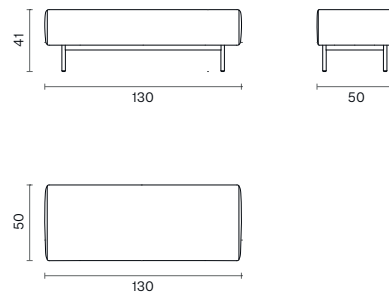

**POUF 41H - P82X50**

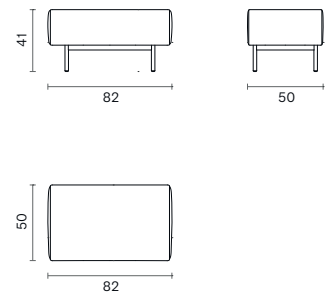

# PIU CONFIGURATIONS

Plan 01

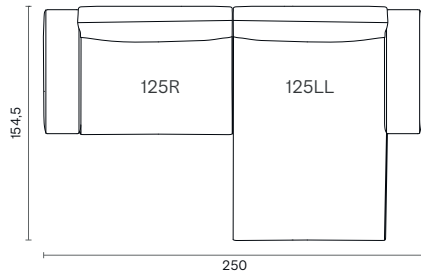

Plan 02

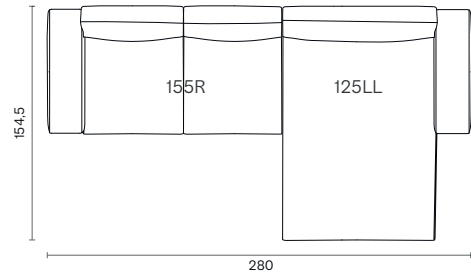

Plan 03

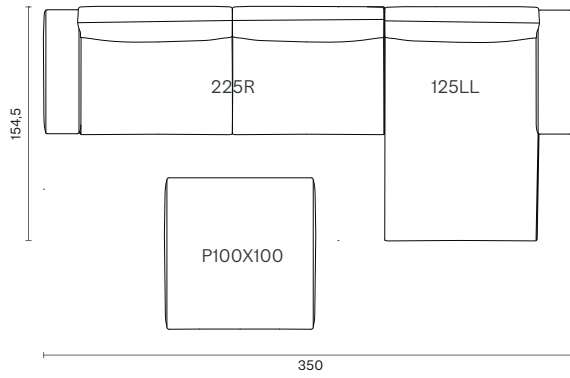

Plan 04

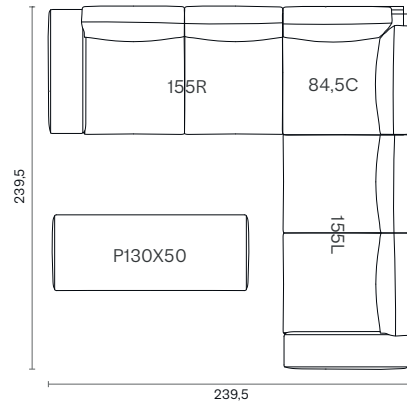

Plan 05

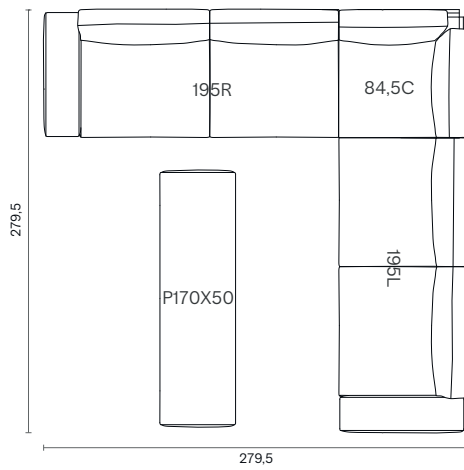

Plan 06

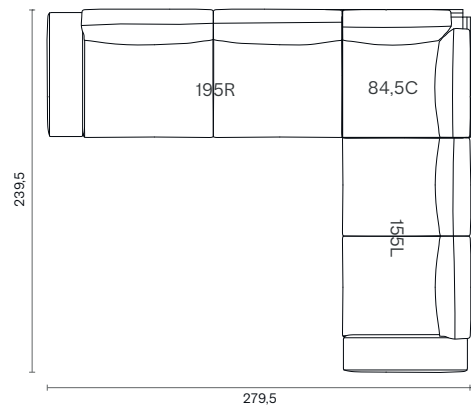

Plan 07

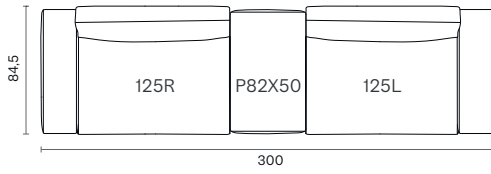

Plan 08

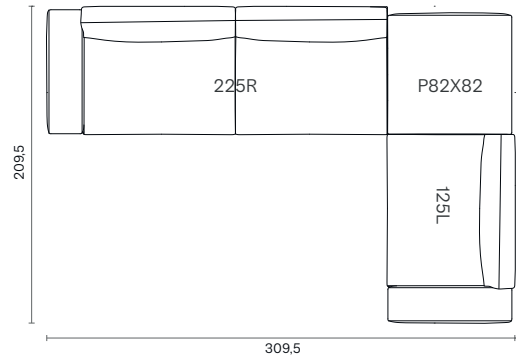

Plan 09

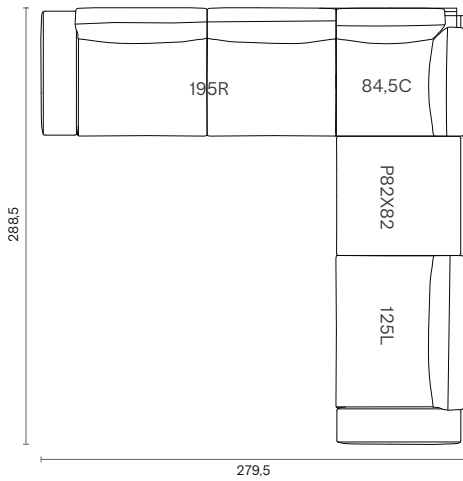

Plan 10

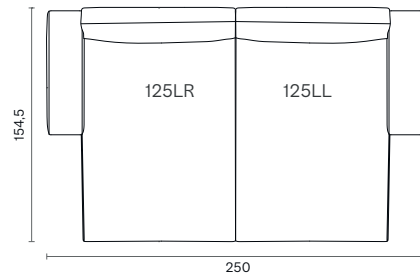

Plan 11

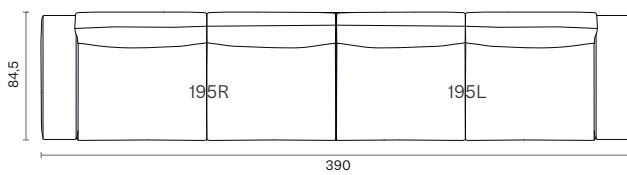

## Downloads ↓

CAD files and photos are available at [bt.design](https://bt.design)

Care and maintenance instructions are available at [bt.design](https://bt.design)

## Warranty

The guarantee policy of B&T Design protects their products in case of any defects regarding manufacturing and materials up to 5 years starting from the date of the invoice. Damages caused by lack of proper maintenance or misuse are not included in this warranty.